

INSTALLATION GUIDE

Everything you wanted to know but were too afraid to ask

3-CIRCUIT TRACK

DALI 6 Wires 3-Circuit Track System

WHOA, HOLD IT!

- 1 Turn power off before install and maintenance to prevent electric shock.
- 2 Track installation must only be performed by qualified electricians.
- 3 Strictly use 220-240 voltage lamps. Incorrect voltage may cause permanent damage to the lamp.
- 4 Avoid installing on a hot surface, near steam, corrosive gas areas or nuclear power plants.
- 5 Ensure track is tightly installed. We do not want track to fall.
- 6 System is IP20 rated. This means it is to be used in dry and dust-free indoor spaces only.
- 7 Use only one power feed at one point on a system.
- 8 Do not change the internal connections. Compatibility with other track system and accessories is not guaranteed.
- 9 Do not apply paint or glue to the product.
- 10 During installation, the connector's **concave** groove must align with the **convex** stripe in the track otherwise it may cause no power for one phase, and has the risk of over voltage damage for 3 phases.
- 11 All illustrations in this installation guide are shown from the **bottom view**, as indicated by the screw marks, representing the side visible to a person standing below and looking up at the ceiling after installation. When checking or positioning accessories on site, the electrician must orient all components according to this same bottom-view perspective to ensure correct installation.
- 12 Do not listen to U2 while installing.

LOAD BEARING REQUIREMENTS FOR TRACK

- 1 Track can be installed to cement, brick or plywood surface.
- 2 Track can be installed using the following materials: M4x30mm self-tapping screws in most scenarios however installer must select a suitable fixing depending on the substrate that the track is being installed on. The selected screw must be of sufficient rating/strength to be able to safely carry the load being installed to avoid the track falling out of the ceiling.
- 3 Please refer to **DISTRIBUTION OF TRACK MOUNTING HOLES & SIZE** table.
- 4 Maximum weight of 30kg allowed per length of the track, no matter the length.



IP20

RoHS



NO JOUSTING

DALI 6 WIRES 3-CIRCUIT TRACK SYSTEM



1. Ensure the "concave" stripe in the accessories is aligned with the "convex" stripe in the track.
2. Tighten the screw on the accessory to fix it in place.

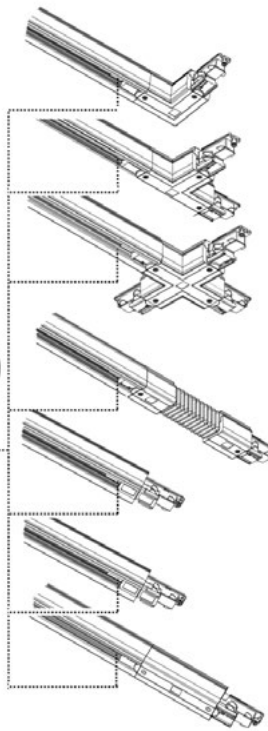
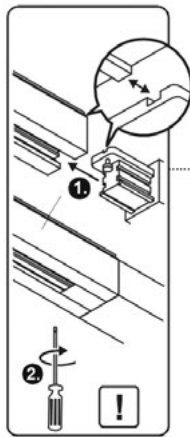

Item Code Nomenclature:

xx = 01 for white
 xx = 02 for black
 xx = 08 for silver

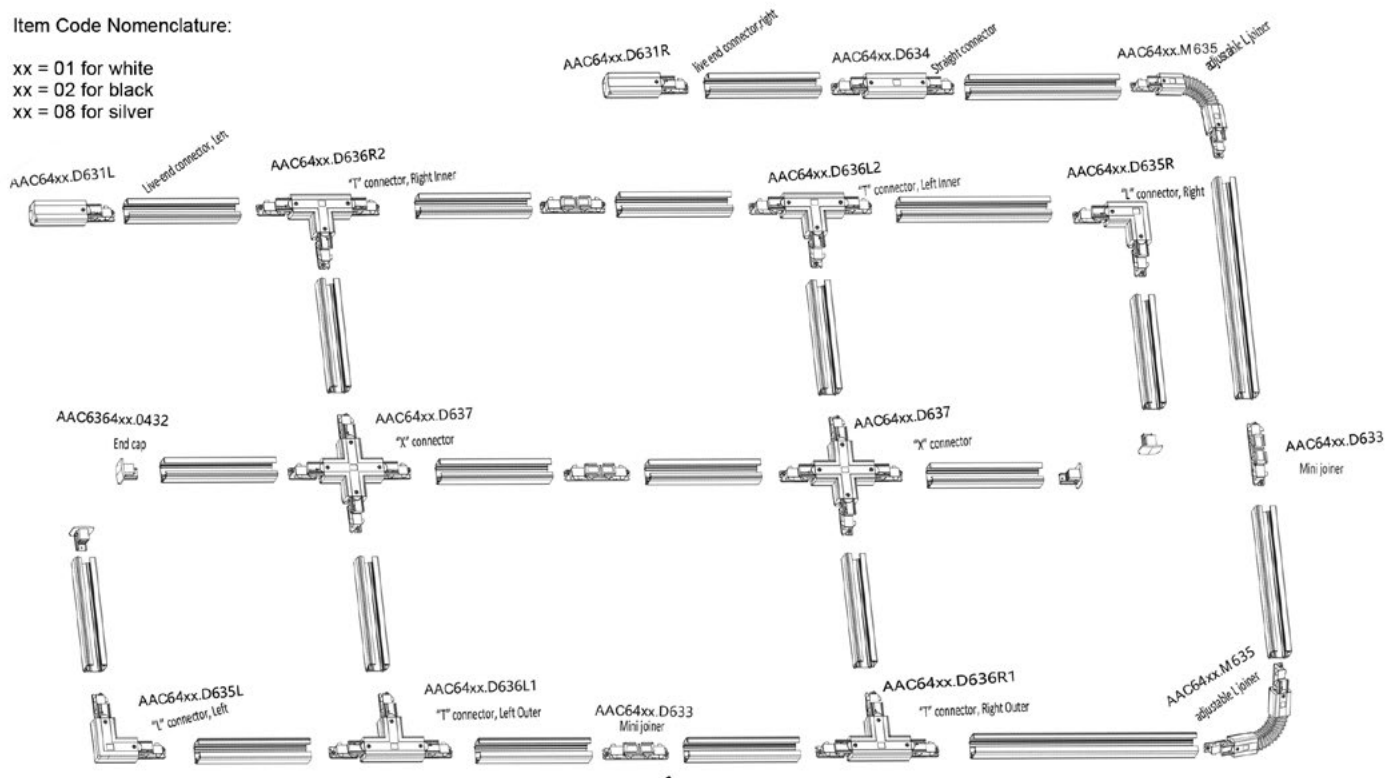

LIVE END CONNECTORS

Red line on the diagram indicates the polarity ridge.

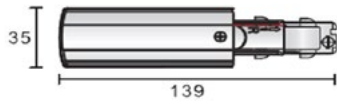

RIGHT
AAC64xx.D631R
xx=WH/BK/SI

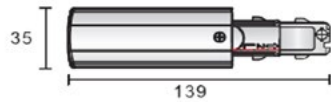
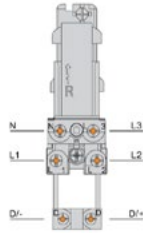

LEFT
AAC64xx.D631L
xx=WH/BK/SI

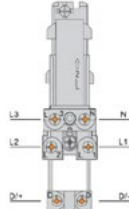

STRAIGHT CONNECTOR

Red line on the diagram indicates the polarity ridge.

a) This joiner can accept a power feed. b) Not to be used for recess mount.

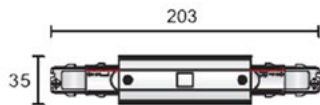

AAC64xx.D634
xx=WH/BK/SI



ADJUSTABLE 'L' JOINER

Red line on the diagram indicates the polarity ridge.

a) Not to be used for recess mount.

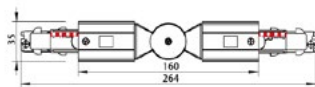

AAC64xx.M635
xx=WH/BK/SI



'L' CONNECTORS

Red line on the diagram indicates the polarity ridge.

a) This joiner can accept a power feed.

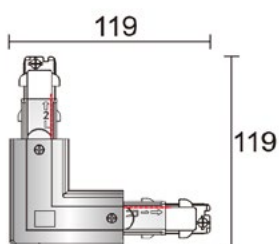

RIGHT
AAC64xx.D635R
xx=WH/BK/SI

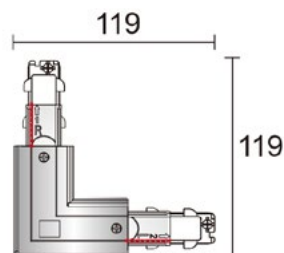

LEFT
AAC64xx.D635L
xx=WH/BK/SI



'T' CONNECTORS

Red line on the diagram indicates the polarity ridge.

a) This joiner can accept a power feed.

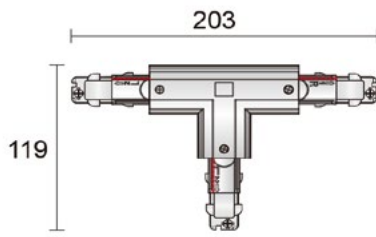

RIGHT OUTER
AAC64xx.D636R1
xx=WH/BK/SI

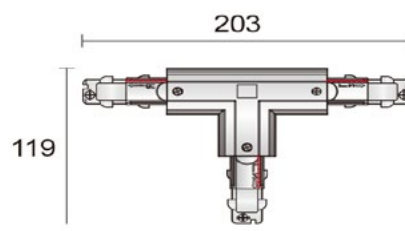

LEFT OUTER
AAC64xx.D636L1
xx=WH/BK/SI

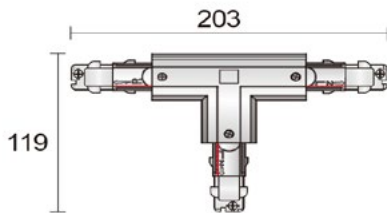

RIGHT INNER
AAC64xx.D636R2
xx=WH/BK/SI

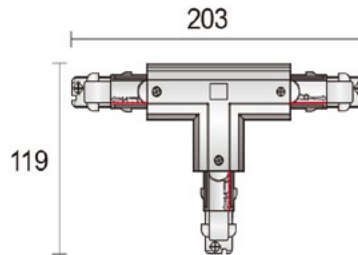

LEFT INNER
AAC64xx.D636L2
xx=WH/BK/SI



'X' CONNECTORS

Red line on the diagram indicates the polarity ridge.

a) This joiner can accept a power feed.

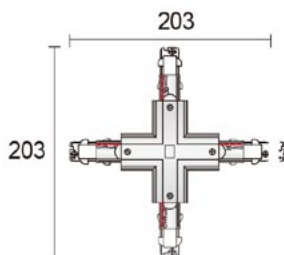

AAC64xx.D637
xx=WH/BK/SI



END CAPS

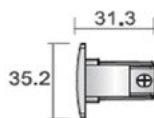

AAC6364xx.0432
xx=WH/BK/SI



MINI JOINER

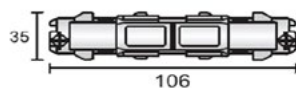

AAC64xx.D633
xx=WH/BK/SI



STRENGTHENING CLAMP

To be used behind mini joiner for suspension mount to firm up the joint.

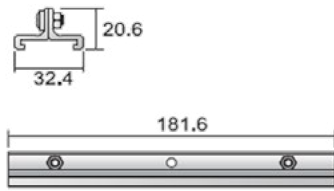

AAC6364xx.0418SK
xx=WH/BK/SI



COVER PLATE FOR 'L' CONNECTOR

To be used for recess mount.

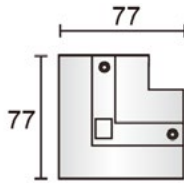

AAC6364xx.R435
xx=WH/BK/SI



COVER PLATE FOR 'T' CONNECTOR

To be used for recess mount.

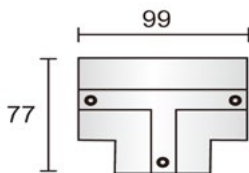

AAC6364xx.R436
xx=WH/BK/SI



COVER PLATE FOR 'X' CONNECTOR

To be used for recess mount.

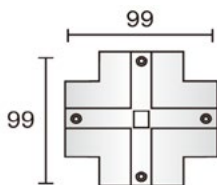

AAC6364xx.R437
xx=WH/BK/SI



COVER PLATE FOR LIVE END CONNECTOR

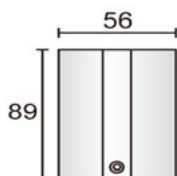

AAC64xx.R631
xx=WH/BK/SI



SURFACE MOUNT TRACK INSTALLATION

1

Mount according to the size and position of holes on the track and install expansion screws accordingly.

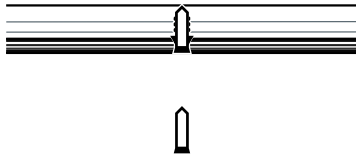

2

Use screws to fix the track.

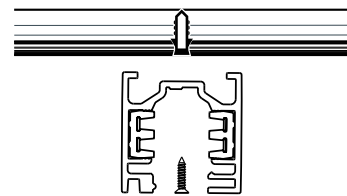

3

Drill and imagine the soothing sound of an orchestra. Once complete bow to your audience.

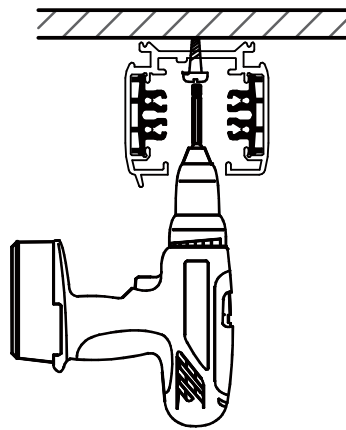

DISTRIBUTION OF TRACK MOUNTING HOLES & SIZE

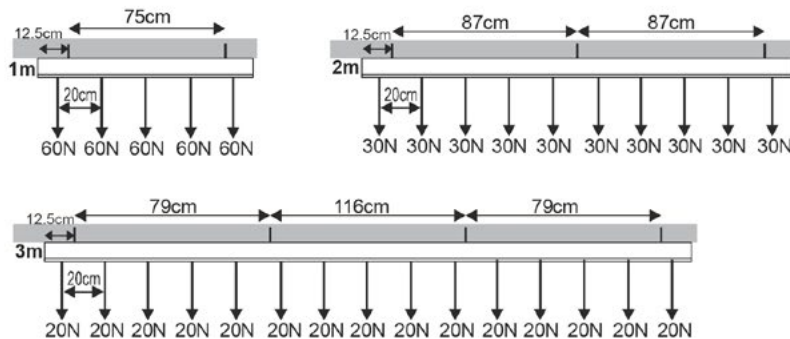

Length (mm)	No. of Holes	Maximum Weight Allowance per length	Self-tapping Screw Size	Hole Size (based on plastic wall plug)
1000	2	30kg	Ø4x30mm	Ø6mm
2000	3	30kg	Ø4x30mm	Ø6mm
3000	4	30kg	Ø4x30mm	Ø6mm

SUSPENSION MOUNT TRACK INSTALLATION

1

Install ceiling fixing.

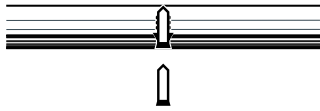

2

Separate the stainless steel suspension barrel, fix into the ceiling.

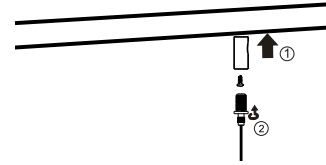

3

Place suspension barrel with the ceiling part.

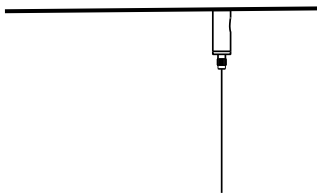

4

Release the start valve, press & get the EZCLICK through the wire-rop. Tighten the start valve & lock the wire-rop.

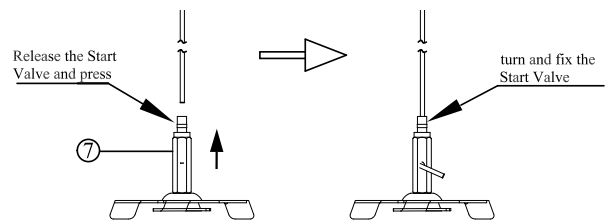

5

Adjust the EZCLICK's direction, put the track into it vertically and then turn it left to fix on the track as shown.

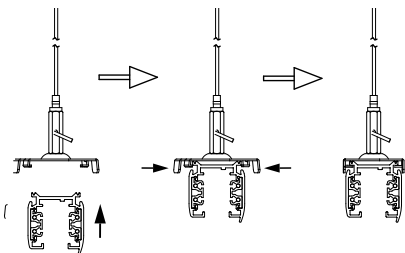

6

Fix strengthening clamp AAC6364xx.0418SK on top of the mini-joiner in between different track lengths.

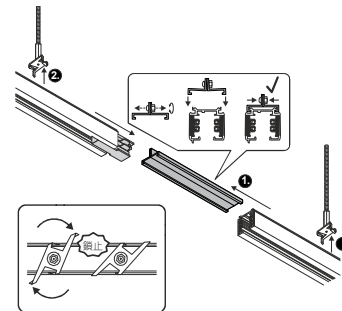

DISTRIBUTION OF TRACK MOUNTING HOLES & SIZE

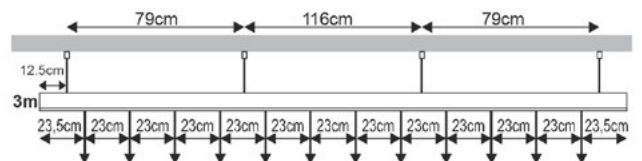
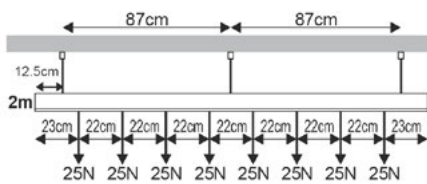
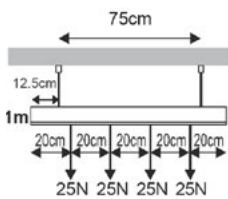

Length (mm)	No. of Suspensions	Maximum Weight Allowance per length
1000	2	30kg
2000	3	30kg
3000	4	30kg

RECESS MOUNT TRACK INSTALLATION

Installer must select suitable screws depending on the type of substrate (metallic/wooden/softer) the track is being installed on. The selected screw must be of sufficient rating/strength to be able to safely carry the load being installed.

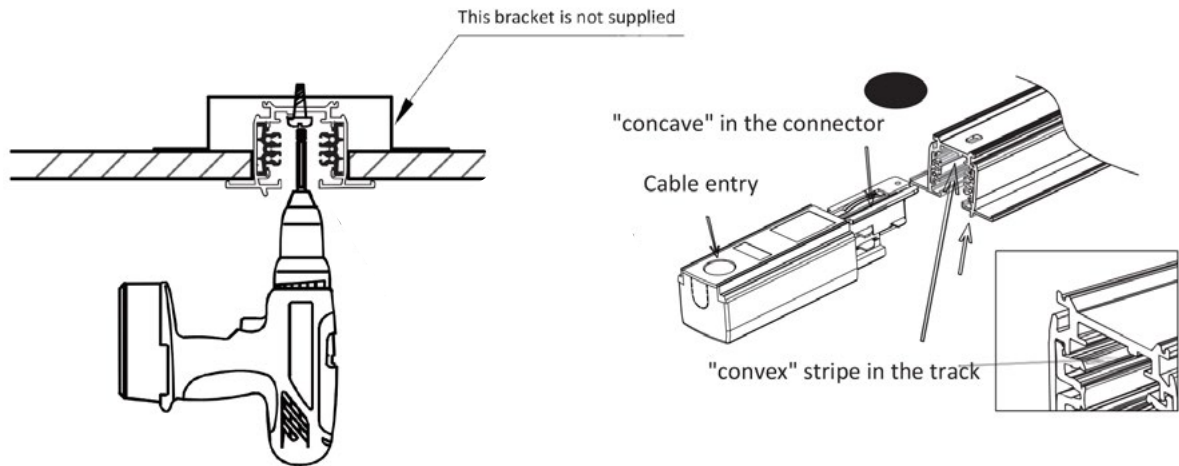

1

Make a rebate in the ceiling as per the dimensions below.

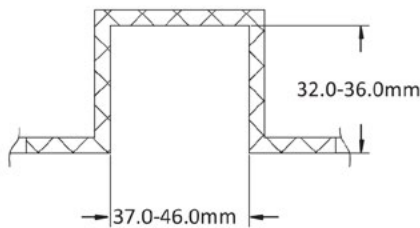

2

Drill holes at the bottom of the rebate as per the size of the track.



3

Use appropriate size screws to hold the track in place inside of the rebate.

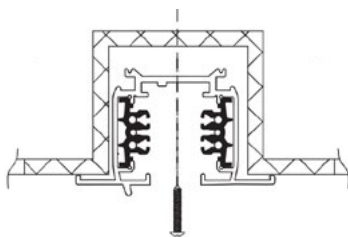

4

Once the screw is in, find someone close to you and say 'That's how you do it'.

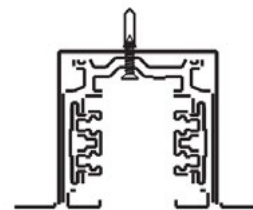

DISTRIBUTION OF TRACK MOUNTING HOLES & SIZE

Length (mm)	No. of Holes	Maximum Weight Allowance per length	Screw Size	Hole Size (based on plastic wall plug)
1000	2	30kg	Ø4x30mm	Ø6mm
2000	3	30kg	Ø4x30mm	Ø6mm
3000	4	30kg	Ø4x30mm	Ø6mm

CUTTING OF TRACK

1

Cut the track as per your required length but do not bend the copper wire. The track ends should be completely vertical, not slanted. Get a little brush out and clean the inside of the track after cutting.

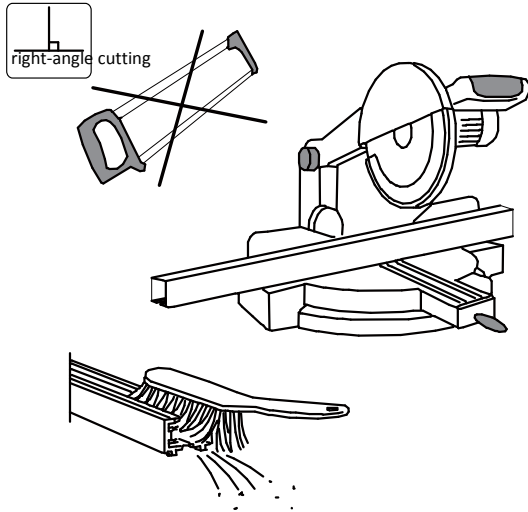

2

If it's all good, celebrate.



STEPS FOR WIRE CONNECTION

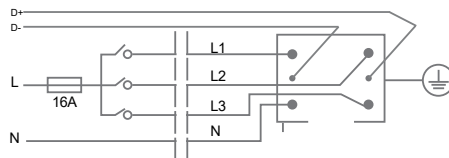
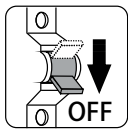

Single-phase electricity 220-250V 16A Max. (EN)

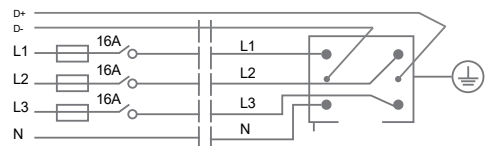

Three-phase electricity 220-250V 3*16A Max. (EN)

1

Open the junction box to connect wires and lock as per image.

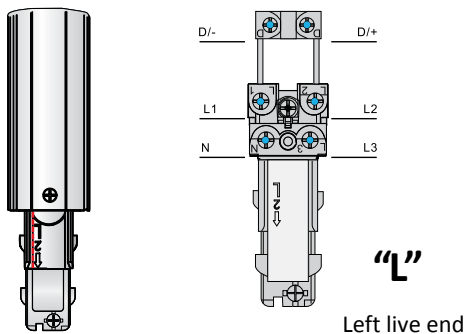

2

D1 (+), D2 (-), L for DALI, 0/1-10V dim signal wire.

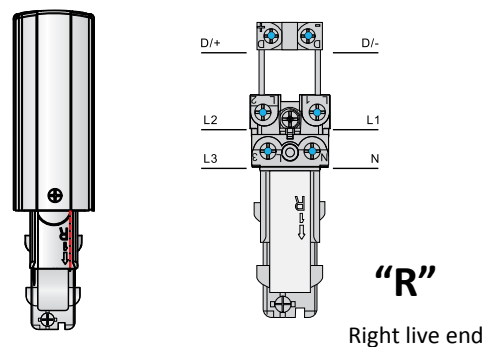

TROUBLESHOOTING

If the track system is out of power, or the voltage value is abnormal, please check the following conditions:

- 1 Please ensure the direction of Live end **L** or **R** is installed correctly, and ensure the **concave** is aligned with the **convex** stripe in the track;
- 2 Please ensure Live end **L** or **R** is installed into the track and the copper flaps are connected to the copper wires;
- 3 Please ensure the terminals **N**, **L1**, **L2**, **L3**, **G** inside of Live end are wired correctly and firmly;
- 4 Please ensure **D+** and **D-** are installed firmly. If using 0-10V dimming, please set positive and negative anodes first.